



Maître Horloger - Les Genevez  
depuis 1884

**EDOXIONARY**  
FOR WATCH PROFESSIONALS  
**2024 - 2025**





**EDOXIONARY**  
FOR WATCH PROFESSIONALS  
**2024 - 2025**



Maître Horloger - Les Genevez  
depuis 1884

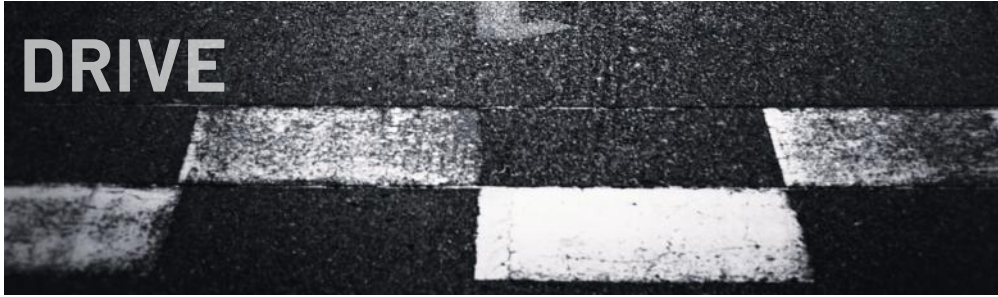

	<p>THE EDOX HISTORY 4</p>
 <p><b>DIVE</b></p>	<p>CO-1 8  NEPTUNIAN 22  DELFIN THE ORIGINAL 32  GRAND OCEAN 50  HYDRO-SUB 58</p>
 <p><b>FLY</b></p>	<p>SKYDIVER 64</p>
 <p><b>DRIVE</b></p>	<p>CHRONORALLY 74</p>
	<p>MARKETING &amp; MORE 86  POS MATERIAL 90  TECHNICAL INFORMATION 98</p>



**1860**

**CHRISTIAN RUEFLI-FLURY**

In 1860, Christian Ruefli-Flury was born in Courrendlin (Switzerland). In 1870, he commenced his horology apprenticeship with Urs Schild before joining the Eterna watch company. In 1883, he married Pauline Flury and worked for Jean Aegler. He then made several contributions to the city of Biel.



**1884**

**IT ALL BEGAN WITH  
A TRUE LOVE STORY**

Christian Ruefli-Flury, produced a pocket watch for the 25th birthday of his beloved wife Pauline. Impressed by this exquisite gift, she convinced her husband to set up his own watch making company in Biel, a city famous for its well-educated watch engineers. Christian Ruefli-Flury called his company "Edox" which means "measuring of time" in ancient Greek.



**1900**

**THE BIRTH OF A LOGO**

The hourglass was officially used as a timeless symbol of Edox and since then, it has been a proud part of the official Edox company logo.

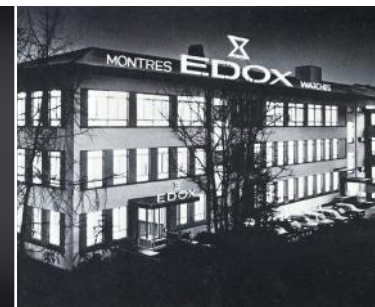

**1955**

**A GROWING COMPANY**

At that time, Edox employed up to 500 watchmakers and the company moved into new, modern and larger production facilities. Edox was amongst Switzerland's leading watch companies.

## THE WATER CHAMPION



1961

1961

DELFIN THE ORIGINAL

The famous "Delfin" timepiece was launched, featuring a double caseback, special protective gaskets and a specially invented double O'ring system, setting new standards of shock protection and water resistance. Edox became known as "The Water Champion" of Swiss watchmaking.



**1965**  
**HYDRO-SUB**

The revolutionary Hydro-Sub collection was launched, featuring the famous double O'crown patented Edox gasket for increased water resistance.



**1970**  
**THE FIRST GENUINE  
WORLD TIME WATCH**

This year saw the introduction of the world's first truly global timepiece, the "Geoscope" watch. Covering all time zones, the watch provided timekeeping for almost 50 different cities around the world, as well as local time.



**1998**  
**WORLD RECORD STILL  
UNBROKEN**

Edox engineers and watchmakers developed the world's slimmest calendar watch, the "Les Bémonts Ultra Slim" collection. The movement had a thickness of only 1.4 mm, which is a technical record still held by Edox to this day.



**2010-2024**  
**THE TIMEKEEPER  
BMW M MOTORSPORT**

After being associated to many prestigious racing competition such as WRC, Rally Dakar, and to the Sauber F1 Team, Edox is now the Official Timing Partner of BMW M Motorsport.

This partnership is a strong testimony of Edox's presence amongst the most renowned and active Swiss watch brands.





1884 **EDOX**  
140<sup>TH</sup> ANNIVERSARY  
2024

### 140 YEARS OF EDOX

In 1884, a love-infused journey began as Christian Ruefli-Flury crafted a heartfelt pocket watch for his wife, marking the birth of Edox. Now, in its 140th year, this Swiss watch brand from Les Genevez stands tall as “The Water Champion,” crafting timeless divers’ watches. A family-owned company, Edox blends heritage with modernity, shaping time for years to come.





COOL  
COOL  
COOL

DIVE



10242 TIN NIN

DIVE

# OFFSHORE INSTRUMENTS

By becoming the Official Timekeeper of the Class-1 World Powerboat Championship in 2007 and creating the CO-1 collection, Edox raised the resistance to water and shocks of its watches to an even higher level.

## COLLECTION'S EVOLUTION



**2007**

Official Timing partner of Class 1 World Powerboat Championship Designed with a scratch-resistant ceramic bezel.



**2007**

Edox presented the second generation of the Class 1 collection in Dubai. For the first time, a punched propeller of a racing boat adorned the 4mm thick case back of the collection. Since that date, the propeller has been an actual symbol of this high-grade sports watch.



**2008**

CO-1 Chronometer Automatic With materials as in the construction of racing boats: ceramic, titanium, steel.



**2010**

The automatic helium valve replaced the manual version and was installed in every CO-1 watch.



**2013**

CO-1 Automatic Chronograph Skeleton - the Ghost Ship.



**2019**

CO-1 Carbon Chronograph Automatic  
New case design: carbon cover.  
Extremely water-resistant.



**2024**

CO-1 Chronograph Automatic Equipped with a bezel lock function, ensuring accurate timing for safer underwater experiences.



01125 CLNGN BUNN



- 1** Strong steel and carbon case construction  
Boîtier solide en acier et carbone  
Stabile Karbon- und Edelstahlkonstruktion  
Caja sólida fabricada en acero y carbono.  
カーボンとセラミックを重ね合わせたハイブリッド  
ケース  
錶殼採用不銹鋼和碳纖維材料，結構材質堅固  
Прочная конструкция корпуса из стали и  
карбона

صلب قوی و عليه من الكربون

- 2** 3 mm thickness of sapphire crystal  
Épaisseur du verre saphir de 3 mm  
3 mm dickes Saphirglas  
Cristal de zafiro de 3 mm  
3mm厚のサファイアクリスタル  
3 毫米厚的藍寶石水晶鏡面  
Сапфировое стекло толщиной 3 мм

زجاجة كريستال بلوري بسمك 3 م

- 3** Automatic Helium valve for specific deep sea diving  
Valve à hélium automatique spécifiquement conçue  
pour la plongée en eau profonde  
Automatisches Heliumventil für Tauchgänge  
Válvula automática de helio para inmersión profunda  
本格的な深海ダイビングのためのオートヘリウム  
バルブ  
特別為深海潛水設計的自動排氦  
Автоматический гелиевый клапан для  
глубоководного погружения

صمام هيليوم أوتوماتيكي خاص بالغوص في أعماق البحار









CARBON CHRONOGRAPH AUTOMATIC  
01125 CLNGN BUNN Ø 45 MM



CARBON CHRONOGRAPH AUTOMATIC  
01125 CLNGN NING Ø 45 MM



CARBON CHRONOGRAPH  
AUTOMATIC **NEW**  
01125 CCN GNO Ø 45 MM



CARBON CHRONOGRAPH  
AUTOMATIC **NEW**  
01125 CCN NR Ø 45 MM





25mm



15.5mm



163g



CHRONOGRAPH  
10242 TINM BUIDN Ø 45 MM



25mm



15.5mm



163g



CHRONOGRAPH  
10242 TINM GIDNO Ø 45 MM



25mm



15.5mm



130g



CHRONOGRAPH  
10242 TIN BUIDN Ø 45 MM



25mm



15.5mm



130g



CHRONOGRAPH  
10242 TINRCA BRDR Ø 45 MM



 QUARTZ  
  
  
  
  
  
  
  
 25mm  
 15.5mm  
 130g  
**CHRONOGRAPH**  
 10242 TIN BUIN Ø 45 MM



 QUARTZ  
  
  
  
  
  
  
  
 25mm  
 15.5mm  
 130g  
**CHRONOGRAPH**  
 10242 TIN NIN Ø 45 MM



 QUARTZ  
  
  
  
  
  
  
  
 25mm  
 15.5mm  
 130g  
**CHRONOGRAPH**  
 10242 TIN VIN Ø 45 MM



 QUARTZ  
  
  
  
  
  
  
  
 25mm  
 15.5mm  
 130g  
**CHRONOGRAPH NEW**  
 10242 TINGNR GIDNR Ø 45 MM



 QUARTZ  
  
  
  
  
  
  
  
 25mm  
 15.5mm  
 130g  
**CHRONOGRAPH**  
 10242 TINR NIR Ø 45 MM



25mm

TITANIUM 15.5mm

100 ATM 130g

CHRONOGRAPH  
10242 TINB BBUINR Ø 45 MM

25mm

TITANIUM 15.5mm

100 ATM 130g

CHRONOGRAPH  
10242 TINB BUICDNO Ø 45 MM

25mm

TITANIUM 15.5mm

100 ATM 130g

CHRONOGRAPH  
10242 TINBN VIDNO Ø 45 MM



Q  
QUARTZ

S

S

S

S

S

S

S

ST  
STEEL

21mm

PVD  
11mm30  
ATM 135g

CHRONOLADY CHRONOGRAPH **NEW**  
10255 357RM BUIDR Ø 38 MM

Q  
QUARTZ

S

S

S

S

S

S

S

ST  
STEEL

21mm

PVD  
11mm30  
ATM 98g

CHRONOLADY CHRONOGRAPH **NEW**  
10255 37RCA BRDR Ø 38 MM

Q  
QUARTZ

S

S

S

S

S

S

S

ST  
STEEL

21mm

PVD  
11mm30  
ATM 98g

CHRONOLADY CHRONOGRAPH **NEW**  
10255 37RBCAB BEIDR Ø 38 MM







# NEP TUN IAN

DIVE



808013NRY NIR

DIVE

# HIGH PRESSURE RESISTANT

Water-resistant to an incredible 1'000m, the Edox Neptunian is built ultra-tough to handle not only the pressures of the deep but, thanks to its strong and durable stainless-steel case, anything on the surface as well. A 3mm-thick sapphire crystal protects the classic, clean dial encircled by a ceramic bezel. The case back features a striking engraving of Neptune, the Roman God of the Sea.

NEPTUNIAN

## COLLECTION'S EVOLUTION



**1969**

**SkyDiver Automatic**  
Original produced for Swiss paratroopers.



**1973**

**SkyDiver Automatic**  
Second generation with greater water-resistance.



**2019**

**SkyDiver Military Automatic**  
Reedition of the SkyDiver from 1973



**2020**

**SkyDiver Neptunian Automatic**  
Evolution of a Legend, first SkyDiver Neptunian.



**2021**

**First Edox Neptunian**  
The Neptunian completes its evolution and becomes an independent collection



**2023**

**Neptunian Grande Réserve**  
Taking this collection to a whole new level with a generous 68- hour power reserve.



80801 3NRM NIR



- 1** Highly water-resistant up to 300 meters / 30 ATM  
 Excellente résistance à l'eau jusqu'à 300 mètres / 30 ATM  
 Extrem wasserdicht bis zu 300 Meter / 30 ATM  
 300 Meter / 30 ATM  
 Alta resistencia al agua hasta 300 metros / 30 ATM  
 300m/30ATM高防水  
 深潛300米防水  
 Высокая степень водозащиты до 300 метров/30 ATM

مقاومة عالية للماء حتى 300 متر / 30 ضغط



- 2** Rotating ceramic bezel  
 Lunette tournante en céramique  
 Drehbarer Tauchring aus Keramik  
 Bisel de cerámica giratorio  
 回転式セラミックベゼル  
 可旋轉的陶瓷錶圈  
 Вращающийся керамический безель

إطار دوار من السيراميك



- 3** 3 mm thickness of sapphire crystal  
 Épaisseur du verre saphir de 3 mm  
 3 mm dickes Saphirglas  
 Cristal de zafiro de 3 mm  
 3mm厚的サファイアクリスタル  
 3毫米厚的藍寶石水晶鏡面  
 Сапфировое стекло толщиной 3 мм

زجاجة كريستال بلوري بسمك 3 م



- 4** Superluminova applied on the hands and indices for reinforced luminescence (60% better than standard quality)  
 Superluminova appliqué sur les aiguilles et index pour une luminescence renforcée (60% meilleure que la qualité habituelle)  
 Indizes sowie Zeiger mit Leuchtmasse (Superluminova GL X1) beschichtet. Dies führt zu einer ca. 60% besseren Leuchtkraft gegenüber einer Standardqualität.  
 Superluminova en agujas e índices para reforzar la luminiscencia (60% mejor que la calidad standard)  
 アップライドインデックスと針にスーパールミノヴァを採用。(通常のルミノヴァよりも60%以上の発光)  
 加強夜光效果的指針與刻度, (比標準亮度高出60%)  
 Суперлюминова нанесена на стрелки и индексы для обеспечения более яркого свечения (на 60% лучше стандартного качества)

طلاء سوبرلومينوفا الفسفوري على عقارب الساعة وعلى الأرقام لإضاءة قوية (أقوى بـ 60٪ من النوعية العادية)

GRANDE RESERVE DATE AUTOMATIC **NEW**  
808013BUM BUIN Ø 42 MM

GRANDE RESERVE DATE AUTOMATIC **NEW**  
808013NM NIN Ø 42 MM

GRANDE RESERVE DATE AUTOMATIC **NEW**  
808013VM VDN Ø 42

GRANDE RESERVE DATE AUTOMATIC **NEW**  
808013NRM NIR Ø 42 MM

GRANDE RESERVE DATE AUTOMATIC **NEW**  
808013BBUM BUCDN Ø 42 MM







DATE AUTOMATIC  
80120 3NM BUIDN Ø 44 MM



DATE AUTOMATIC  
80120 3NM NIN Ø 44 MM



DATE AUTOMATIC  
80120 3NM BRD Ø 44 MM



DATE AUTOMATIC  
80120 3BUM BUF Ø 44 MM





DATE AUTOMATIC  
80120 3VM NIN Ø 44 MM





DATE AUTOMATIC  
80120 3VM VDN1 Ø 44 MM





DATE AUTOMATIC **NEW**  
80120 357JM NID Ø 44 MM

DATE AUTOMATIC **NEW**  
80120 357JM AID Ø 44 MM



DATE AUTOMATIC **NEW**  
80120 37JCA AID Ø 44 MM



DATE AUTOMATIC **NEW**  
80120 37JCA NID Ø 44 MM



DATE AUTOMATIC  
80120 37RNNCA NIR Ø 44 MM



MARIANNA GILLESPIE  
WATER CHAMPION AMBASSADOR

World Record holder and  
seven-times World Champion.

# DEL FIN

DIVE



85303 357RN NRN

DIVE

# THE WATER CHAMPION WATCH

The Delfin collection was first launched in 1961 and used revolutionary watch parts such as double O'ring gaskets for crowns and pushers and a special shock absorbing caseback in order to withstand an impressive water resistance of 200 meters.

Nowadays, this special equipment is still featured in Edox Delfin timepieces.

## COLLECTION'S EVOLUTION



**1961**

Delfin The Original  
First Edox watch equipped with  
a double O'ring and a double  
caseback.



**1969**

Delfin The Original  
First Edox watch equipped with  
a double O'ring and a double  
caseback.



**1973**

Delfin with its iconic  
dodecagonal bezel.



**2020**

Delfin Mecano  
Skeletonised dial and  
movement bring 21st Century  
twist to the legendary  
design.



10113 3CAB BUIH



- 1** Superluminova applied on the hands and indices for reinforced luminescence (60% better than standard quality)  
 Superluminova appliqué sur les aiguilles et index pour une luminescence renforcée (60% meilleure que la qualité habituelle)  
 Indizes sowie Zeiger mit Leuchtmasse (Superluminova GL X1) beschichtet. Dies führt zu einer ca. 60% besseren Leuchtkraft gegenüber einer Standardqualität.  
 Superluminova en agujas e índices para reforzar la luminiscencia (60% mejor que la calidad standard)  
 アップライドインデックスと針にスーパールミノヴァを採用。(通常のルミノヴァよりも60%以上の発光)  
 加強夜光效果的指針與刻度, (比標準亮度高出60%)  
 Суперлюминова нанесена на стрелки и индексы для обеспечения более яркого свечения (на 60% лучше стандартного качества)

طلاء سوبرلومينوفا الفسفوري على عقارب الساعة وعلى الأرقام لإضاءة قوية  
 (أقوى بـ 60% من النوعية العادية)

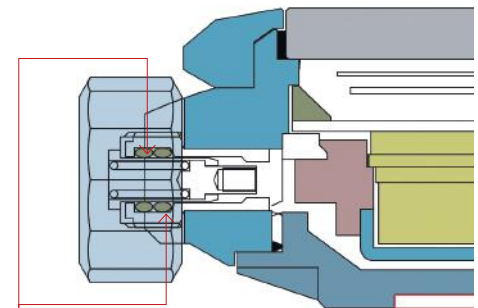

- 2** Double O'rings for crowns and pushers, special shock absorbing caseback  
 Joints doubles pour la couronne et les poussoirs, fond spécial pour absorber les chocs  
 Krone und Drücker mit Doppel-O-Ring-Dichtung; verstärkter Gehäuseboden für besondere Stossicherheit  
 Juntas dobles en coronas y pushers, tapa especial con mayor protección antigolpes  
 ダブルOリングを備えたリューズとプッシュボタン、耐衝撃性能のケースバック  
 雙防水圈的錶冠及按把, 特殊防震後蓋,  
 Двойные O-прокладки заводных головок и кнопок хронографа, специальный амортизирующий корпус  
 حلقتان للتيجان والمكبس، وغطاء خلفي مصمم لامتصاص الصدمات



MECANO AUTOMATIC  
85303 3NM NBG Ø 43 MM



MECANO AUTOMATIC  
85303 3M BUIGB Ø 43 MM



MECANO AUTOMATIC  
85303 357RN NRN Ø 43 MM



MECANO AUTOMATIC  
85303 357GN NGN Ø 43 MM



MECANO AUTOMATIC  
85303 357GR NRN Ø 43 MM







DELFIN





DAY DATE



ST  
STEEL

PVD

20  
ATM

24mm

12.7mm

125g



DAY DATE AUTOMATIC **NEW**  
88008 37GNCA GBEI Ø 43 MM



DAY DATE



ST  
STEEL

PVD

20  
ATM

24mm

12.7mm

125g



DAY DATE AUTOMATIC **NEW**  
88008 37RGCA GIR Ø 43 MM





CHRONOGRAPH  
10113 37GNCA NGIN Ø 43 MM

CHRONOGRAPH  
10113 37GNCA GNO Ø 43 MM

CHRONOGRAPH **NEW**  
10113 37JM AID Ø 43 MM

CHRONOGRAPH **NEW**  
10113 37JM NID Ø 43 MM

CHRONOGRAPH  
10113 37RNCA NIR Ø 43 MM











- QUARTZ
- SWISS MADE
- STAINLESS STEEL
- 20 ATM
- 24mm
- 10,3mm
- 160g

DATE **NEW**  
53021 3M JIN Ø 43 MM



- QUARTZ
- SWISS MADE
- STAINLESS STEEL
- PVD
- 20 ATM
- 24mm
- 10,3mm
- 160g

DATE **NEW**  
53021 3GM GIN Ø 43 MM



- QUARTZ
- SWISS MADE
- STAINLESS STEEL
- PVD
- 20 ATM
- 24mm
- 10,3mm
- 160g

DATE **NEW**  
53021 37GNM NDR Ø 43 MM



- QUARTZ
- SWISS MADE
- STAINLESS STEEL
- 20 ATM
- 24mm
- 10,3mm
- 110g

DATE **NEW**  
53021 3GCA OINO Ø 43 MM



- QUARTZ
- SWISS MADE
- STAINLESS STEEL
- PVD
- 20 ATM
- 24mm
- 10,3mm
- 110g

DATE **NEW**  
53021 37RNCA NIR Ø 43 MM



 QUARTZ  
  
  
  
  
  
 ST STEEL  
 20 YEAR WARRANTY  
 20 ATM  
 20mm  
 11.3mm  
 137g

**DIVER DATE LADY  
 SPECIAL EDITION**  
 53020 3M BUDDR Ø 38 MM





 QUARTZ  
  
  
  
  
  
 ST STEEL  
 20 YEAR WARRANTY  
 20 ATM  
 20mm  
 11.3mm  
 137g

**DIVER DATE LADY**  
 53020 3M NADN Ø 38 MM





 QUARTZ  
  
  
  
  
  
 ST STEEL  
 20 YEAR WARRANTY  
 20 ATM  
 20mm  
 11.3mm  
 137g

**DIVER DATE LADY**  
 53020 3M BUN Ø 38 MM





 QUARTZ  
  
  
  
  
  
 ST STEEL  
 20 YEAR WARRANTY  
 20 ATM  
 20mm  
 11.3mm  
 137g

**DIVER DATE LADY**  
 53020 3M NANND Ø 38 MM





 QUARTZ  
  
  
  
  
  
 ST STEEL  
 20 YEAR WARRANTY  
 20 ATM  
 20mm  
 11.3mm  
 137g

**DIVER DATE LADY**  
 53020 3D120M NADN Ø 38 MM





 QUARTZ  
  
  
  
  
  
 ST STEEL  
 20 YEAR WARRANTY  
 20 ATM  
 20mm  
 11.3mm  
 137g

**DIVER DATE LADY**  
 53020 3D120M NANND Ø 38 MM



QUARTZ  
 WATER RESISTANT  
 SWISS MADE  
 STAINLESS STEEL  
 PVD  
 20 ATM  
 20mm  
 11.3mm  
 137g

**DIVER DATE LADY NEW**  
 53020 357JM NADD Ø 38 MM

EDox  
 Since 1945 - 1946 - 1947  
 Since 1889  
 DIAMOND CERTIFICATE

QUARTZ  
 WATER RESISTANT  
 SWISS MADE  
 STAINLESS STEEL  
 PVD  
 20 ATM  
 20mm  
 11.3mm  
 137g

**DIVER DATE LADY NEW**  
 53020 37JM NADD Ø 38 MM

EDox  
 Since 1945 - 1946 - 1947  
 Since 1889  
 DIAMOND CERTIFICATE

QUARTZ  
 WATER RESISTANT  
 SWISS MADE  
 STAINLESS STEEL  
 PVD  
 20 ATM  
 20mm  
 11.3mm  
 137g

**DIVER DATE LADY NEW**  
 53020 37JM NID Ø 38 MM

QUARTZ  
 WATER RESISTANT  
 SWISS MADE  
 STAINLESS STEEL  
 PVD  
 20 ATM  
 20mm  
 11.3mm  
 79g

**DIVER DATE LADY**  
 53020 37JC NADD Ø 38 MM

EDox  
 Since 1945 - 1946 - 1947  
 Since 1889  
 DIAMOND CERTIFICATE

QUARTZ  
 WATER RESISTANT  
 SWISS MADE  
 STAINLESS STEEL  
 PVD  
 20 ATM  
 20mm  
 11.3mm  
 79g

**DIVER DATE LADY**  
 53020 37JC NANRUD Ø 38 MM

QUARTZ  
 WATER RESISTANT  
 SWISS MADE  
 STAINLESS STEEL  
 PVD  
 20 ATM  
 20mm  
 11.3mm  
 79g

**DIVER DATE LADY**  
 53020 37RC NANR Ø 38 MM





**GRA**

**ND**

**OCEAN**

**DIVE**



098003CA BUIJN

# SPIRIT OF THE OCEAN

Edox has always had a special bonding with the sailing world. In 2008, Edox made his first step into world class sailing with a major timekeeping project for international regattas. The Grand Ocean collection crowns this statement by proposing since many years timepieces that feature an unforgettable look and great ingenuity.

## COLLECTION'S EVOLUTION



**2009**

Launch of the first Grand Ocean watch

Edox Grand Ocean Jumping Hour designed in collaboration with Sea Dubai Sailing.



**2013**

Grand Ocean Chronograph Automatic

Inspired by the partnership with the Extreme Sailing Series.



**2017**

Grand Ocean Phantom of Time Automatic

Adding an extra touch of refinement.



**2024**

Grand Ocean Power Reserve Automatic

Infusing a modern twist into timeless elegance.



09800 3CA BUIN



- 1** Crown equipped with double O'ring for perfect water resistance  
 Couronne équipée d'un double joint pour une étanchéité parfaite  
 Krone mit Doppel-O-Ring-Dichtung für perfekte Wasserdichtheit  
 Corona con doble junta para una perfecta resistencia al agua  
 ダブルリングを備えたリユーズにより優れた防水性能を発揮します。  
 配備完美防水的雙防水圈錶冠  
 Заводная головка оснащена двойной O-прокладкой для идеальной водонепроницаемости

امدل تي لاثم ةمواقم ل ج و د زم م متخ عم ج ات



- 2** Highly water-resistant up to 300 meters / 30 ATM  
 Excellente résistance à l'eau jusqu'à 300 mètres / 30 ATM  
 Extrem wasserdicht bis zu 300 Meter / 30 ATM  
 300 Meter / 30 ATM  
 Alta resistencia al agua hasta 300 metros / 30 ATM  
 300m/30ATM高防水  
 深潛300米防水  
 Высокая степень водозащиты до 300 метров/30 ATM

مقاومة عالية للماء حتى 300 متر / 30ATM ضغط



- 3** Typical Grand Ocean triple horn design  
 Design Grand Ocean typique à triple corne  
 Dreiteiliger Bandanstoss, typisch für die Grand Ocean  
 Diseño típico de Grand Ocean con tres asas  
 グランドオーシャンの特徴のトリプルホーン(三股)デザイン  
 性能を発揮します。  
 帆船系列具特有的三叉錶殼設計  
 Типичный для Grand Ocean дизайн с тройными ушками

نم ةي ج ذوم ن ي هو ، ءازج ء ءثالت نم ءنوكم ل ا م ارح ل ا ءورع Grand Ocean





CHRONOGRAPH AUTOMATIC **NEW**  
09800 3CA BUIN Ø 43 MM



CHRONOGRAPH AUTOMATIC **NEW**  
09800 3CA NIN Ø 43 MM



CHRONOGRAPH AUTOMATIC **NEW**  
09800 357GNCA NIBU Ø 43 MM



CHRONOGRAPH AUTOMATIC **NEW**  
09800 357RCA AIR Ø 43 MM





18,5mm

13,4mm

140g

POWER RESERVE AUTOMATIC **NEW**  
94500 3CA BUIN Ø 40 MM



18,5mm

13,4mm

140g

POWER RESERVE AUTOMATIC **NEW**  
94500 3CA NIN Ø 40 MM



18,5mm

13,4mm

140g

POWER RESERVE AUTOMATIC **NEW**  
94500 3CA BUCR Ø 40 MM

GRAND OCEAN



18,5mm

13,4mm

140g

POWER RESERVE AUTOMATIC **NEW**  
94500 357GNCA NIR Ø 40 MM

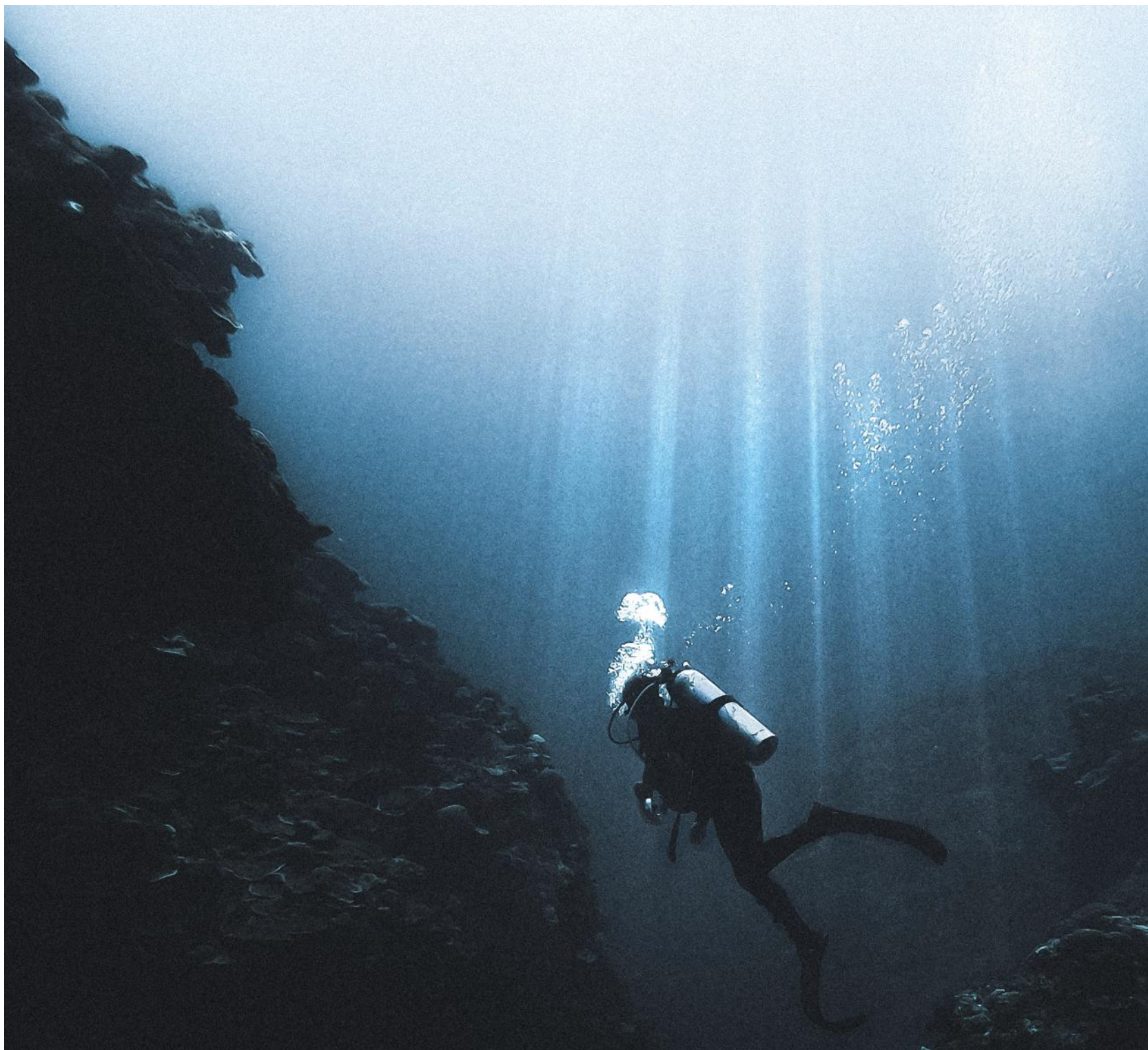



# **HYD RO- SUB** DIVE

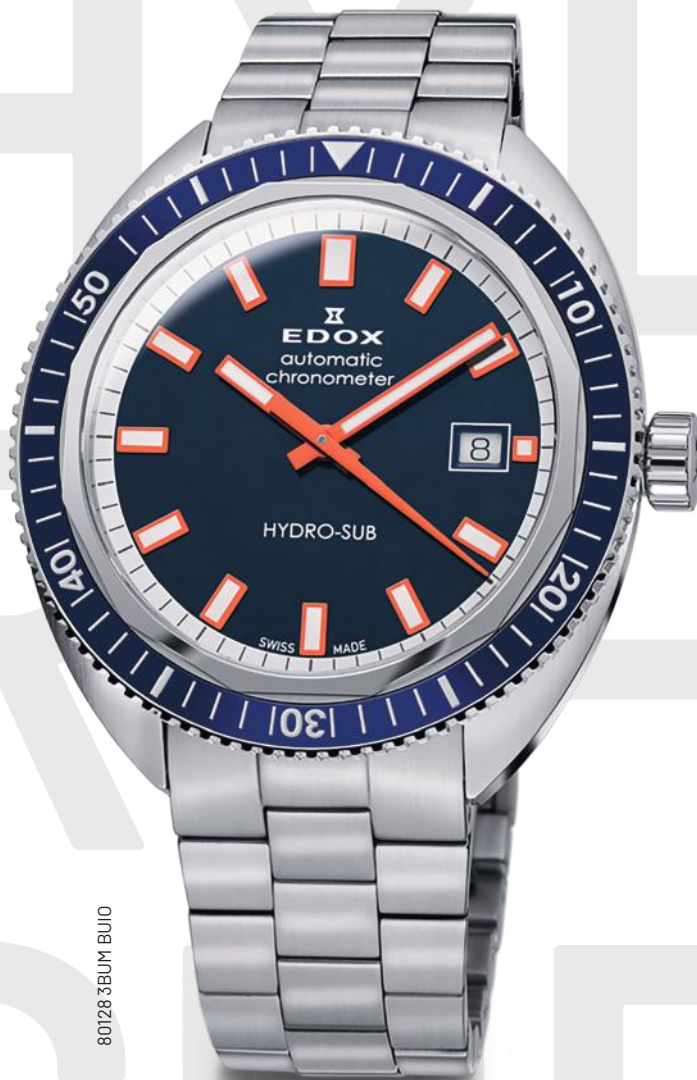

80128 3BUM BUJO

# THE SUBMARINE WATCH

The Hydro-Sub Special Edition is new, improved and with 21st century smarts – but still infused with the timelessly cool DNA of the original 1960s Hydro-Sub, the timepiece that helped make Edox the ‘water champion’ of the watch industry.

## COLLECTION'S EVOLUTION



**1965**

Original Hydro-Sub

Water-resistant down to 500m, an incredible achievement in the 1960s.



**2014**

Edox Hydro-Sub North Pole Limited Edition

A certified chronometer featuring an inhouse developed crown protection system named “Master-Lock”.



**2021**

Hydro-Sub Automatic Chronometer

Improved but still infused with the timelessly cool DNA of the original 1960s.









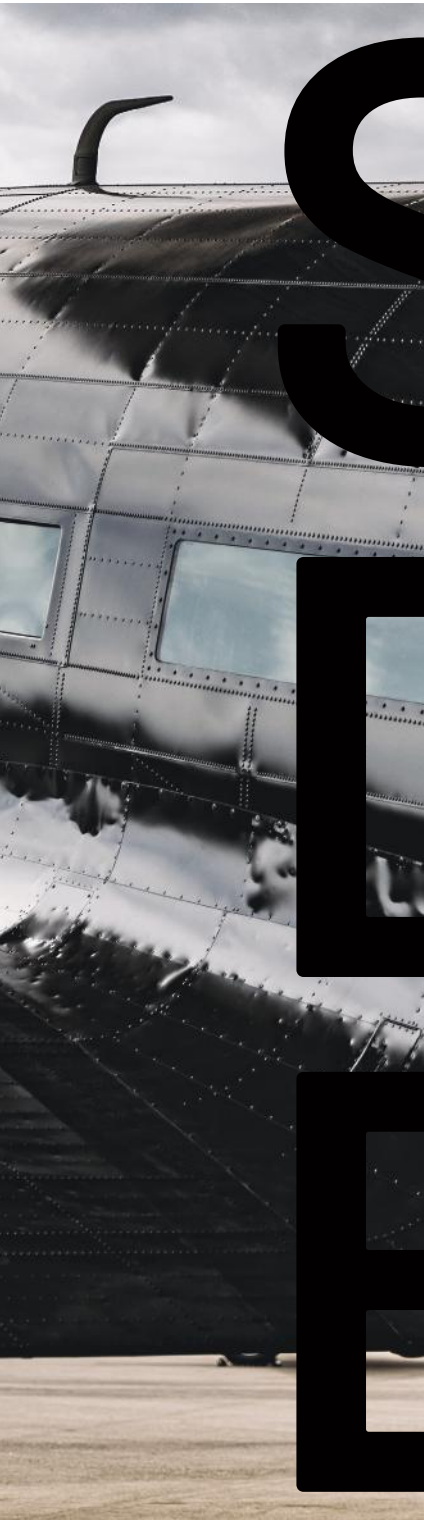

# SKY DIVER ER

FLY



80126 357RNM NIRB

# ON LAND, AIR OR SEA

Rumoured to be launched following a Swiss colonel secret request in 1973, the SkyDiver collection pays tribute to paratroopers and the extreme conditions they might face – on land, air or sea.

## COLLECTION'S EVOLUTION



**1969**

SkyDiver Automatic  
Original Produced for Swiss  
paratroopers.

**1973**

SkyDiver Automatic  
Second generation with  
greater water-resistance.



**2019**

SkyDiver Military Automatic  
Reedition of the SkyDiver  
from 1973



**2021**

Reedition of the SkyDiver  
Original



80126 357RNM NIRB



- 1** Screw-down crown  
 Couronne vissée  
 Sicherheitsschraubkrone  
 Corona de seguridad enroscable  
 ネジ込み式リュウズ  
 旋緊式安全表冠  
 Закручивающаяся  
 защитная коронка

زر تاج مشندود



- 2** Superluminova X1 on hands and indices  
 Superluminova X1 sur les aiguilles et indexes  
 Superluminova X1 auf den Zeigern sowie Indizes  
 Superluminova X1 en manecillas e índices.  
 スーパールミノバを施した針とインデックス  
 指針和時標採用 Superluminova X1 超越夜光物料  
 Покрытие Superluminova X1 на стрелках и  
 индексах

سوبرلومینوفا على العقارب والمؤشرات



- 3** Rotating ceramic bezel  
 Lunette tournante en céramique  
 Drehbarer Tauchring aus Keramik  
 Bisel de cerámica giratorio  
 回転式セラミックベゼル  
 可旋轉的陶瓷錶圈  
 Вращающийся керамический безель

إطار دوار من السيراميك

Paratroopers emblem on the caseback  
 Insigne des parachutistes de l'armée gravé sur le fond  
 Geprägtes Fallschirmjäger Emblem auf der  
 Gehäuserückseite  
 Emblema de los paracaidistas en la tapa del reloj  
 パラシュート部隊のエンブレムをあしらったケース  
 バック  
 底蓋刻有傘兵圖案  
 Эмблема парашютиста на задней крышке

شعار المظليين على العلية الخلفية

Design inspired by the original SkyDiver model from 1973.  
 Design inspiré par le modèle original SkyDiver de 1973.  
 Das Design stammt von der originalen SkyDiver Uhr aus dem Jahre 1973.  
 Diseño inspirado en el modelo original SkyDiver de 1973.  
 1973年にリリースした軍用時計「スカイダイバー」の復刻デザイン  
 設計靈感來自1973年的 SkyDiver 原型  
 Дизайн вдохновлен оригинальной моделью SkyDiver 1973 года.

التصميم مستوحى من الموديل الاصلى للاسكاي ديفر منذ عام 1973











22mm  
13.9mm  
162g

DATE AUTOMATIC  
80126 357RNM NIRB Ø 42 MM  
LIMITED EDITION OF 600 PIECES

EXTRA LEATHER STRAP











22mm  
13.9mm  
162g

DATE AUTOMATIC  
80126 3BUM BUIN Ø 42 MM  
LIMITED EDITION OF 600 PIECES

EXTRA NYLON STRAP











22mm  
13.9mm  
99g

DATE AUTOMATIC  
80126 3VIN GDN Ø 42 MM  
AGED STEEL  
LIMITED EDITION OF 600 PIECES

EXTRA LEATHER STRAP











22mm  
13.9mm  
99g

DATE AUTOMATIC  
80126 BRN BUIDR Ø 42 MM  
LIMITED EDITION OF 600 PIECES

EXTRA LEATHER STRAP







38 DATE AUTOMATIC  
80131 3BUM BUIIN Ø 38 MM



38 DATE AUTOMATIC  
80131 3NM NIB Ø 38 MM



38 DATE AUTOMATIC  
80131 3BUC BUIICO Ø 38 MM  
SPECIAL EDITION



38 DATE AUTOMATIC  
80131 3NC VI Ø 38 MM  
SPECIAL EDITION



38 DATE AUTOMATIC  
80131 37RNC VDBEI Ø 38 MM  
SPECIAL EDITION





- QUARTZ
- 30 ATM
- WATERPROOF
- SWISS MADE
- ST STEEL
- 40mm
- 13.7mm
- 139g

CHRONOGRAPH **NEW**  
WITH TELEMETER SCALE  
10116 3 BUIDN Ø 40 MM



- QUARTZ
- 30 ATM
- WATERPROOF
- SWISS MADE
- ST STEEL
- 40mm
- 13.7mm
- 139g

CHRONOGRAPH **NEW**  
WITH TELEMETER SCALE  
10116 3 GRIDN Ø 40 MM



- QUARTZ
- 30 ATM
- WATERPROOF
- SWISS MADE
- ST STEEL
- 40mm
- 13.7mm
- 139g

CHRONOGRAPH **NEW**  
WITH TELEMETER SCALE  
10116 3 VIDN Ø 40 MM



**EDOX**

Maitre Horloger - Les Genevez  
depuis 1884

Official Timing  
Partner



**Motorsport**





**CHR**

**DRIVE**

**ONO**

**RALLY**



38001 TINIBU BN

# RALLY INSTRUMENTS

The Chronorally is a revolutionary chronograph with new, sophisticated technical functions originally developed for rally drivers. It has been the official collection of FIA World Rally Championship (WRC), the Dakar Rally, the FIA World Rallycross championship and for the former Formula 1 team Sauber. It will now be worn by BMW drivers.

## COLLECTION'S EVOLUTION



1972

Sportsman Chronograph



2010

Official Timing Partner of the  
WRC World Rally Championship



2017

Chronorally Sauber F1 Team  
Limited Edition



2019

Chronorally FIA World Rallycross  
Limited Edition



2022

Chronorally Limited Edition  
inspired by the sponsorship with  
BMW M Motorsport.



2024

Reedition of the Sportsman  
Chronographe Automatic  
Inspired by the original  
model from 1972 and by the  
sponsorship with BMW M  
Motorsport.



38001 TINNBU BN



- 1** Over-sized pusher for perfect grip on the watch commands  
 Pousoir de grande taille pour une maîtrise parfaite des fonctions de la montre  
 Besonders grosser Drücker für sicheren Zugriff auf die Uhrenfunktionen  
 Pusher de gran tamaño para una sujeción perfecta de los mandos  
 時計の操作がしやすい大型プッシュボタン  
 超大尺寸計時按把為手錶贏得十足的吸引力  
 Увеличенная кнопка хронографа для удобного использования часов

مكبس كبير لتحكم مثالي في ضبط الساعة

- 2** Rubber strap with tyre imprints  
 Bracelet en caoutchouc avec design empreintes de pneu  
 Kautschukarmband mit Reifenprofil  
 Correa de caucho con motivos de neumáticos  
 タイヤ模様のラバーストラップ  
 車胎紋矽橡膠帶  
 Каучуковый ремешок с рисунком протектора шин

سوار مطاطي مزين برسوم العجلات

- 3** Robust titanium construction for extreme use conditions  
 Construction en titane pour des conditions d'utilisation extrêmes  
 Robuste Titanausführung für Widerstandsfähigkeit unter Extrembedingungen  
 Construído en titanio macizo para condiciones extremas de uso  
 過酷な環境下にも耐え得る堅牢なスチール構造  
 堅硬鈦金屬結構適合用於激烈的情況下使用  
 Прочный титановый корпус для использования в экстремальных условиях

بنية من الفولاذ الصلب لتحمل ظروف الاستعمال القاسية



- Q QUARTZ
- SWISS MADE
- WATER RESISTANT
- ANTI-MAGNETIC
- 2 1 8 REG. DATE
- CHRONOGRAPH
- S
- TITANIUM
- PVD
- 10 ATM
- 25mm
- 15mm
- 130g



Official Timing Partner  
   
**Motorsport**

CHRONOGRAPH  
 LIMITED EDITION OF 2'000 PIECES  
 38001 TNR BUDN Ø 48 MM ADDITIONAL STRAP

- Q QUARTZ
- SWISS MADE
- WATER RESISTANT
- ANTI-MAGNETIC
- 2 1 8 REG. DATE
- CHRONOGRAPH
- S
- TITANIUM
- PVD
- 10 ATM
- 25mm
- 15mm
- 130g



Official Timing Partner  
   
**Motorsport**

CHRONOGRAPH  
 LIMITED EDITION OF 2'000 PIECES  
 38001 TINNBU BN Ø 48 MM ADDITIONAL STRAP

- Q QUARTZ
- SWISS MADE
- WATER RESISTANT
- ANTI-MAGNETIC
- 2 1 8 REG. DATE
- CHRONOGRAPH
- S
- TITANIUM
- PVD
- 10 ATM
- 25mm
- 15mm
- 130g



CHRONOGRAPH **NEW**  
 38001 TINNR VR Ø 48 MM

DRIVE CHRONORALLY











Inspired by the glorious heritage of 1970s motorsport and the original model from 1972, the new EDOX Sportsman Chronographe Automatic embodies the competitive essence and elegance of that legendary age while also celebrating EDOX's 140th anniversary.



Original EDOX Sportsman  
Chronographe Automatic from 1972



Transparent caseback with the anniversary logo  
engraved on the rotor.



## SPONSORING

OFFICIAL TIMING PARTNER OF  
BMW M MOTORSPORT

Edox is the exclusive “Official Timing Partner” of BMW M Motorsport. The partnership includes engagements in the BMW Junior Team, the BMW M2 Cup, as well as the GT3 highlight, the 24h race at the Nürburgring.

This sponsorship is a strong testimony of Edox’s presence amongst the most renowned and active Swiss watch brands.

MARIANNA GILLESPIE  
WATER CHAMPION AMBASSADOR

The Russian-born Frenchwoman, is the current French national and world record holder in multiple disciplines. Marianna has been world champion seven times, ranked No. 1 in the world multiple times and she is also the youngest winner of the prestigious Vertical Blue competition.

She is an ambassador for the iconic Edox Delfin diver’s watch collection and offered product-specific guidance to further refine the new Delfin lady collection.







CO-1  
10242 TIN NIN



CHRONOGRAPH AUTOMATIC  
01128 3NOCA BUIDN



NEPTUNIAN AUTOMATIC  
80120 3NM BUIDN



GRANDE RESERVE DATE AUTOMATIC  
80801 3NRM NIR



DELFIN  
85303 357RN NRN



DELFIN  
85303 357GN NGN



DELFIN  
85303 357GNCAV VONB



DATE AUTOMATIC CHROMETER  
80128 3BUM BUIO



CHRONORALLY AUTOMATIC  
38001 TINNBV BN



SPORTSMAN CHRONOGRAPHE  
AUTOMATIC 08202 3G GIN



38 DATE AUTOMATIC  
80131 3NM NIB



SKYDIVER DATE AUTOMATIC  
80126 BRN BUIDR

## DISPLAYS

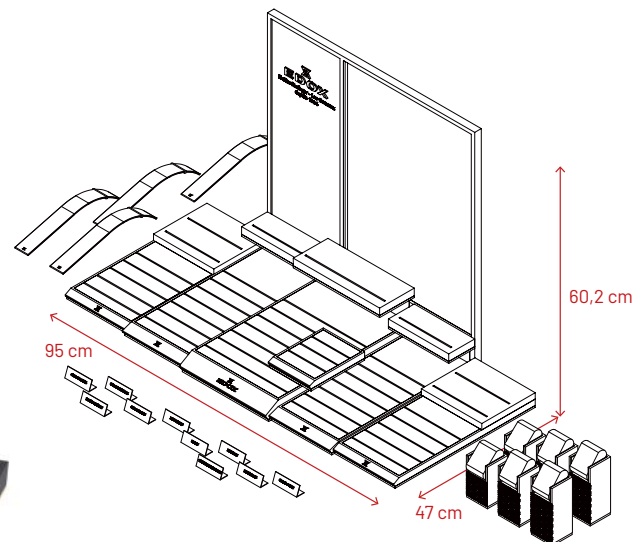

- 1111 Edox Big Display
- 44 C-rings
  - 1 Base
  - 2 Sides
  - 4 Tobogans
  - 6 Watch Stands
  - 10 Product Plates

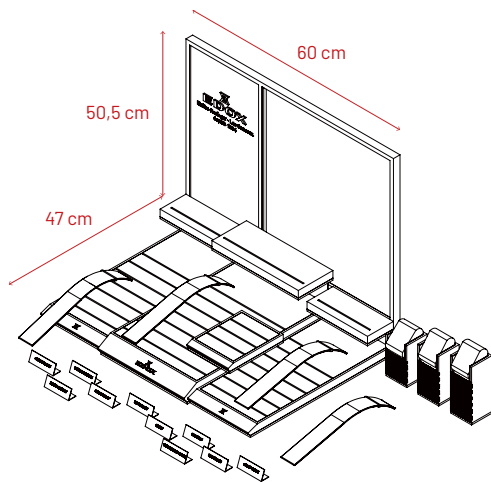

- 1112 Edox Medium Display
- 30 C-rings
  - 1 Base
  - 4 Tobogans
  - 3 Watch Stands
  - 10 Product Plates



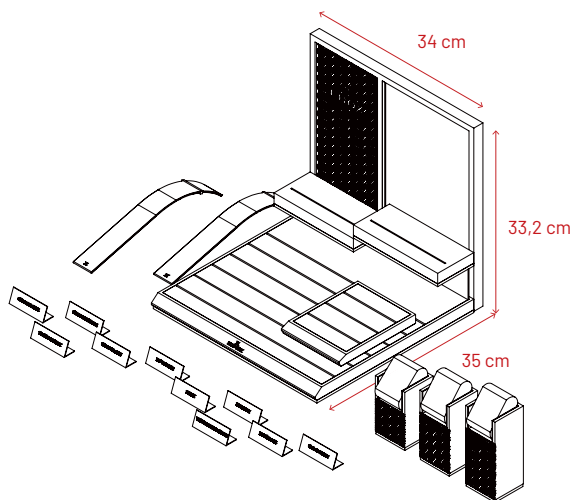

1114 Edox Small Display

- 9 C-rings
- 1 Base
- 2 Tobogans
- 3 Watch Stands
- 10 Product Plates

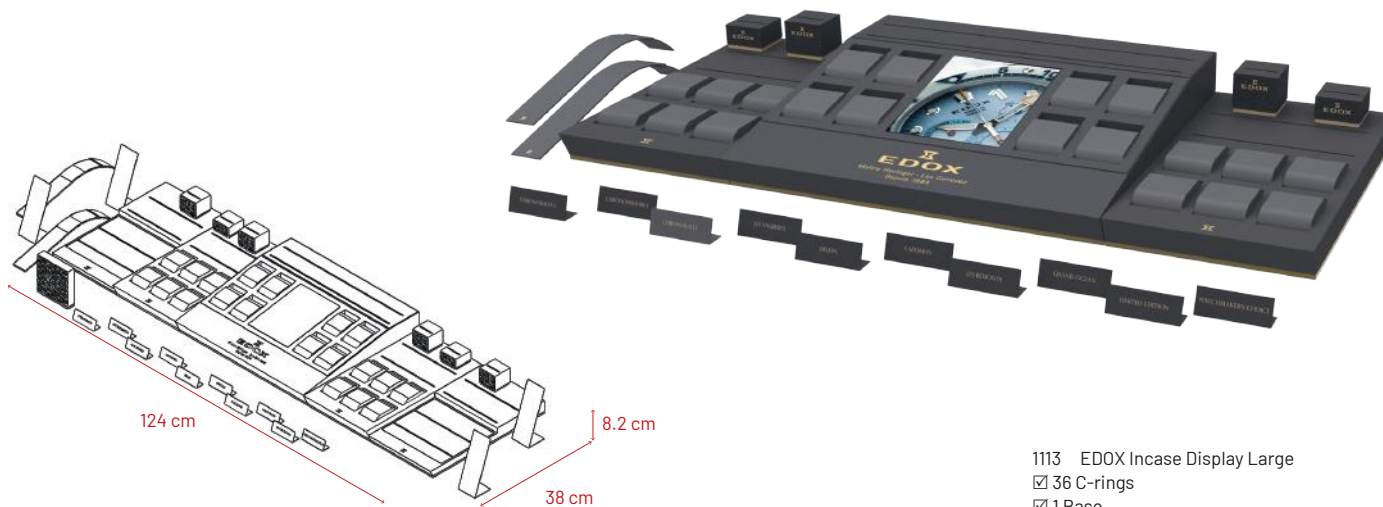

1113 EDOX Incase Display Large

- 36 C-rings
- 1 Base
- 2 Tobogans
- 3 Watch Stands 3cm
- 3 Watch Stands 4.5cm
- 10 Product Plates

## SHOP IN SHOP

All item finishes may be finalized,  
please contact us accordingly.



1124 EDOX Counter, including display material  
(W 141 x D 50 x H 120 cm)



1123 EDOX Free Standing Show Cabinet, including  
display material  
(W 50 x D 50 x H 160 cm)



1125 EDOX Wall  
(W 180 x D 50 x H 240 cm)  
Dimensions can be adapted



## DISPLAY ACCESSORIES



1115 EDOX Watch Stand  
Set of 3 pieces  
4, 6 and 8 cm height



1118 Edox Retailer Plate  
W 10 x D 2.2 x H 10 cm



1159 EDOX Chronorally wall clock  
Ø 40cm - 3.5kg



1119 Edox Product Plate  
(set of 6 plates, available in Chinese, English, French,  
German, Japanese, Polish, Russian and Spanish)



1116 Edox Presentation Tray  
35 x 32 cm

## PACKAGING - CATALOGUES - CERTIFICATES



1143 New Packaging for all collections with warranty card



1088 After Sale Service and Duty Free Programme Watch Box



1110 Edox Selvyt



4059 Edox Black Gloves



1138 Edox shopping bag



0041 Edoxionary for watch professionals

## GIVE-AWAYS



1140 Edox Watch winder  
W 11.5 x D 15 x H 11.5cm



1137 Edox Umbrella



1162 Edox Outdoor Duffle Bag  
50 liters



1166 Edox Water-resistant White Cap



1153 Edox Water-resistant Black Cap



1146 Edox Key Holder



1168 Edox Notebook



1133 Edox Lanyard



# TECHNICAL INFORMATION



**MOVEMENTS**

**CLASP & BUCKLE**

**EDOX QUALITY**

**REFERENCE NUMBER SYSTEM**

**PICTOGRAMS**



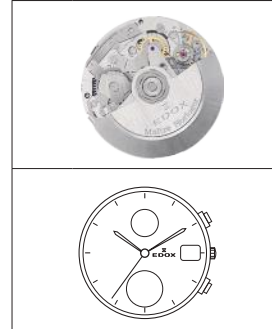





## MECHANICAL MOVEMENTS

CALIBER / MANUFACTURER	07	SW 300 DUBOIS-DÉPRAZ 312	08	DUBOIS-DÉPRAZ 2040	082	SW 510 BH B	098	SW 500 BV B
MOVEMENT								
FUNCTIONS	Display of hours, minutes, seconds and date. 24 time zone display		Display of hours, minutes, seconds, date and chronograph		Display of hours, minutes, small second and chronograph.		Display of hours, minutes, date, chronograph and date	
Frequency	28'800 A/h		28'800 A/h		28'800 A/h		28'800 A/h	
Power reserve	40-44 h		38h		62h		62 h	
Diameter	25.60 mm (11 1/2'')		25.60 mm (11 1/2'')		30.00 mm (13 1/4'')		30.00 mm (13 1/4'')	
Movement height	4.85 mm		7.50 mm		7.90 mm		7.90mm	
Number of jewels	25 jewels		50 jewels		27 jewels		25 jewels	
Shock resistance	Incabloc		Novodiac or Etachocs		Incabloc		Incabloc	
Max. variation all positions	22 s/d		30s/ds		20 s/d		20 s/d	





  

CALIBER / MANUFACTURER	011	VALJOUX 7750 / SW500	80	ETA 2824 / SW 200	802	SW 200	805	SW 280-1
MOVEMENT								
FUNCTIONS	Display of hours, minutes, seconds and date, chronograph, day and date		Display of hours, minutes, seconds and date		Display of hours, minutes, seconds and date		Display of hours, minutes, seconds, date and moon phase	
Frequency	28'800 A/h		28'800 A/h		28'800 A/h		28'800 A/h	
Power reserve	62h		38 h		38 h		38 h	
Diameter	30.00 mm (13 1/4'')		25.60 mm (11 1/2'')		25.60 mm (11 1/2'')		25.60 mm (11 1/2'')	
Movement height	7.90 mm		4.60 mm		3.60 mm		5.40 mm	
Number of jewels	25 jewels		25 jewels / 26 jewels		26 jewels		26 jewels	
Shock resistance	Incabloc		Novodiac or Etachocs		Incabloc		Novodiac	
Max. variation all positions	20 s/d		30 s/d		30 s/d		30 s/d	



## MECHANICAL MOVEMENTS

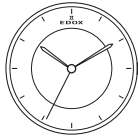



CALIBER / MANUFACTURER	806	SW 200 COSC CERTIFIED	808	LA JOUX-PERRET G100	83	ETA 2834 / SW 240	85	ETA 2824 / SW 200
MOVEMENT								
								
FUNCTIONS	Display of hours, minutes, seconds and date		Display of hours, minutes, seconds and date		Display of hours, minutes, seconds, day and date		Display of hours, minutes and seconds	
Frequency	28'800 A/h		28'800 A/h		28'800 A/h		28'800 A/h	
Power reserve	38 h		68h		42 h		38 h	
Diameter	25.60 mm (11 1/2''')		25.6 mm (11 1/2''')		29.00 mm (13''')		25.60 mm (11 1/2''')	
Movement height	3.60 mm		4.45mm		5.05 mm		4.60 mm	
Number of jewels	26 jewels		24 jewels		26 jewels		25 jewels	
Shock resistance	Incabloc		KIF		Incabloc or Etachocs		Novodiac	
Max. variation all positions	-4/+6 s/d		30 s/d		30 s/d		30 s/d	

CALIBER / MANUFACTURER	853	SW200(SEMI-SKELETONISED)	87	ETA 2892-A2 DUBOIS DÉPRAZ DK 87
MOVEMENT				
				
FUNCTIONS	Display of hours, minutes and seconds		5 minute repeater Indication of time by the tone of 2 striking hammers	
Frequency	28'800 A/h		28'800 A/h	
Power reserve	42 h		42 h	
Diameter	25.60 mm (11 1/2''')		36.00 mm (16''')	
Movement height	4.60 mm		7.35 mm	
Number of jewels	26 jewels		21 jewels	
Shock resistance	Novodiac		Incabloc	
Max. variation all positions	30 s/d		22 s/d	

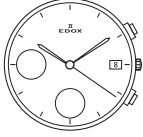
# MECHANICAL MOVEMENTS

CALIBER / MANUFACTURER	88	SW 220-1	91	ETA 2824-2 / SW200 DUBOIS DÉPRAZ 291
MOVEMENT				
				
FUNCTIONS	Display of hours, minutes, seconds, day and date		Display of hours, minutes, seconds, date and chronograph	
Frequency	28'800 A/h		28'800 A/h	
Power reserve	38 h		38 h	
Diameter	25.6mm (11 1/2''')		30.00 mm (13 1/4''')	
Movement height	5.05 mm		7.50 mm	
Number of jewels	26 jewels		46 jewels	
Shock resistance	Incabloc		Incabloc	
Max. variation all positions	30 s/d		30 s/d	

CALIBER / MANUFACTURER	945	SW 279-1	95	ETA 2894 S2L
MOVEMENT				
				
FUNCTIONS	Display of hours, minutes, small second, power reserve and date		Display of hours, minutes, seconds and chronograph	
Frequency	28'800 A/h		28'800 A/h	
Power reserve	41 h		42 h	
Diameter	25.60 mm (11 1/2''')		28.00 mm (12 1/2''')	
Movement height	5.60 mm		6.10 mm	
Number of jewels	31 jewels		37 jewels	
Shock resistance	Incabloc		Incabloc	
Max. variation all positions	20 s/d		30 s/d	

QUARTZ MOVEMENTS

CALIBER / MANUFACTURER	0165	ETA G10.962
MOVEMENT		
FUNCTIONS	Display of hours, minutes, seconds, chronograph, moon phase	
Diameter	31.75 mm (13 1/4"')	
Movement height	5.12 mm	
Battery	N° 394	

CALIBER / MANUFACTURER	095	ISA 8371.B
MOVEMENT		
FUNCTIONS	Display of hours, minutes, seconds, date, chronograph	
Diameter	30.60 mm (13 1/4"')	
Movement height	5.50 mm	
Battery	N° 394	

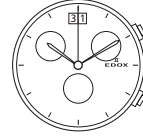
CALIBER / MANUFACTURER	10	RONDA 5040.B
MOVEMENT		
FUNCTIONS	Display of hours, minutes, seconds and big date, chronograph, split time	
Diameter	28.00 mm (12 1/2"')	
Movement height	4.40 mm	
Battery	N° 395	

CALIBER / MANUFACTURER	101	RONDA 5021.D
MOVEMENT		
FUNCTIONS	Display of hours, minutes, seconds, date and chronograph	
Diameter	28.00 mm (12 1/2"')	
Movement height	4.40 mm	
Battery	N° 395	

CALIBER / MANUFACTURER	102	RONDA 5030.D
MOVEMENT		
FUNCTIONS	Display of hours, minutes, seconds, date and chronograph	
Diameter	28.00 mm (12 1/2"')	
Movement height	4.40 mm	
Battery	N° 395	

CALIBER / MANUFACTURER	103	RONDA 5021.D
MOVEMENT		
FUNCTIONS	Display of hours, minutes, seconds, date and chronograph	
Diameter	28.00 mm (12 1/2"')	
Movement height	4.40 mm	
Battery	N° 395	

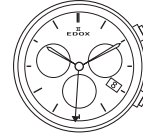
CALIBER / MANUFACTURER	104	RONDA 5040.D
MOVEMENT		
FUNCTIONS	Display of hours, minutes, seconds, date, chronograph	
Diameter	28.00 mm (12 1/2"')	
Movement height	4.40 mm	
Battery	N° 395	

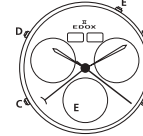
CALIBER / MANUFACTURER	105	RONDA 5040.F
MOVEMENT		
FUNCTIONS	Display of hours, minutes, seconds, day, date, month, chronograph	
Diameter	28.00 mm (12 1/2"')	
Movement height	5.40 mm	
Battery	N° 395	

CALIBER / MANUFACTURER	13N	ETA 251.272
MOVEMENT		
FUNCTIONS	Display of hours, minutes, seconds, date and chronograph	
Diameter	30.00 mm (13 1/2"')	
Movement height	5.00 mm	
Battery	N° 394	

CALIBER / MANUFACTURER	34	RONDA 7004
MOVEMENT		
FUNCTIONS	Display of hours, minutes, small second, date retrograde	
Diameter	33.80 mm (15"')	
Movement height	5.60 mm	
Battery	N° 381	

CALIBER / MANUFACTURER	345	RONDA 7004P
MOVEMENT		
FUNCTIONS	Display of hours, minutes, small second, big date, day retrograde	
Diameter	33.80 mm (15"')	
Movement height	5.60 mm	
Battery	N° 381	

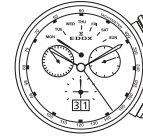
CALIBER / MANUFACTURER	38	RONDA 8040.N
MOVEMENT		
FUNCTIONS	Display of hours, minutes, small seconds, day date, chronograph	
Diameter	33.80 mm (15"')	
Movement height	5.60 mm	
Battery	N° 395	

## QUARTZ MOVEMENTS

CALIBER / MANUFACTURER	38s	RONDA 8020.N
MOVEMENT		
FUNCTIONS	Display of hours, minutes, day date, chronograph	
Diameter	33.80 mm (1 5/8")	
Movement height	5.60 mm	
Battery	N° 395	

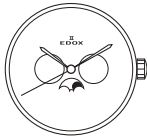
CALIBER / MANUFACTURER	40	RONDA 706.1
MOVEMENT		
FUNCTIONS	Display of hours, minutes, seconds, date and moon phase	
Diameter	23.30 mm (10 1/2")	
Movement height	3.00 mm	
Battery	N° 371	

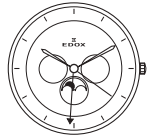
CALIBER / MANUFACTURER	401	RONDA 706.B
MOVEMENT		
FUNCTIONS	Display of hours, minutes, seconds, day date and moon phase	
Diameter	23.30 mm (10 1/2")	
Movement height	3.70 mm	
Battery	N° 371	

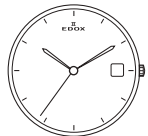
CALIBER / MANUFACTURER	53	RONDA 515
MOVEMENT		
FUNCTIONS	Display of hours, minutes, seconds and date	
Diameter	25.60 mm (1 1/2")	
Movement height	3.00 mm	
Battery	N° 371	

CALIBER / MANUFACTURER	54	RONDA 585
MOVEMENT		
FUNCTIONS	Display of hours, minutes, seconds and date	
Diameter	19.40 mm (8 3/4")	
Movement height	3.00 mm	
Battery	N° 362	

CALIBER / MANUFACTURER	56	RONDA 714
MOVEMENT		
FUNCTIONS	Display of hours, minutes and date	
Diameter	25.60 mm (1 1/2")	
Movement height	2.50 mm	
Battery	N° 371	

CALIBER / MANUFACTURER	57	RONDA 784
MOVEMENT		
FUNCTIONS	Display of hours, minutes and date	
Diameter	19.40 mm (8 3/4")	
Movement height	2.50 mm	
Battery	N° 362	

CALIBER / MANUFACTURER	64	RONDA 6004B
MOVEMENT		
FUNCTIONS	Display of hours, minutes, small seconds and big date	
Diameter	25.60 mm (1 1/2")	
Movement height	3.30 mm	
Battery	N° 373	

CALIBER / MANUFACTURER	84	RONDA 517
MOVEMENT		
FUNCTIONS	Display of hours, minutes, seconds, day and date	
Diameter	25.60 mm (1 1/2")	
Movement height	3.00 mm	
Battery	N° 371	



CO-1



01128	37GNNOCA	CHRONOGRAPH AUTOMATIC	page 13
01128	37GNRCA	CHRONOGRAPH AUTOMATIC	page 13
01125	CCN	CARBON CHRONOGRAPH	page 15
01125	CLNGN	CARBON CHRONOGRAPH AUTOMATIC	page 15
10242	TINGNR	CHRONOGRAPH	page 18
10242	TINR	CHRONOGRAPH	page 18
10242	TINRCA	CHRONOGRAPH	page 17



01128	3NOCA	CHRONOGRAPH AUTOMATIC	page 13
01128	3NRCA	CHRONOGRAPH AUTOMATIC	page 13
10242	TINB	CHRONOGRAPH	page 19
10242	TIN	CHRONOGRAPH	page 18
10255	3CA	CHRONOLADY CHRONOGRAPH	page 20
10255	3BCAB	CHRONOLADY CHRONOGRAPH	page 20



10242	TINM	CHRONOGRAPH	page 17
-------	------	-------------	---------

CO-1

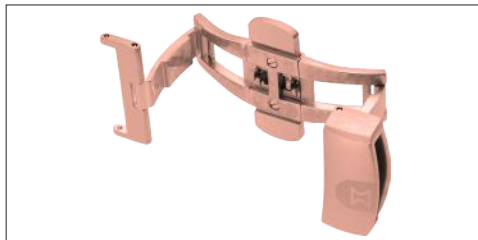

10255	37RCA	CHRONOLADY CHRONOGRAPH	page 21
10255	37RBCAB	CHRONOLADY CHRONOGRAPH	page 21



10255	3M	CHRONOLADY CHRONOGRAPH	page 20
10255	3BM	CHRONOLADY CHRONOGRAPH	page 20
10255	357RM	CHRONOLADY CHRONOGRAPH	page 21

NEPTUNIAN



80120	3NM	DATE AUTOMATIC	page 29
80120	3VM	DATE AUTOMATIC	page 29
80120	3BUM	DATE AUTOMATIC	page 29
80120	357JM	DATE AUTOMATIC	page 31



80801	3BUM	GRANDE RESERVE DATE AUTOMATIC	page 27
80801	3NM	GRANDE RESERVE DATE AUTOMATIC	page 27
80801	3VM	GRANDE RESERVE DATE AUTOMATIC	page 27
80801	3NRM	GRANDE RESERVE DATE AUTOMATIC	page 27
80801	3BBUM	GRANDE RESERVE DATE AUTOMATIC	page 27



80120	37RNNCA	DATE AUTOMATIC	page 31
80120	37JCA	DATE AUTOMATIC	page 31



DELFIN THE ORIGINAL



<b>85303 3M</b>	MECANO AUTOMATIC	page 37
<b>85303 3NM</b>	MECANO AUTOMATIC	page 37



<b>85303 357GNM</b>	MECANO AUTOMATIC	page 38
---------------------	------------------	---------



<b>10113 37JM</b>	CHRONOGRAPH	page 43
-------------------	-------------	---------



<b>10112 3BUM</b>	CHRONOGRAPH	page 44
<b>10112 3NM</b>	CHRONOGRAPH	page 44
<b>10113 3M</b>	CHRONOGRAPH	page 42
<b>88008 3M</b>	DAY DATE AUTOMATIC	page 40
<b>53021 3M</b>	DATE	page 46
<b>53021 3GM</b>	DATE	page 47
<b>53020 357JM</b>	DIVER DATE LADY	page 49

DELFIN THE ORIGINAL



<b>53020 3M</b>	DIVER DATE LADY	page 48
<b>53020 3D120M</b>	DIVER DATE LADY	page 48



<b>53020 37JM</b>	DIVER DATE LADY	page 49
-------------------	-----------------	---------



<b>10112 37GN0CA</b>	CHRONOGRAPH	page 44
<b>10112 37GNVCA</b>	CHRONOGRAPH	page 44
<b>10112 357GRNCA</b>	CHRONOGRAPH	page 44
<b>10113 37GNCA</b>	CHRONOGRAPH	page 43
<b>85303 357GN</b>	MECANO AUTOMATIC	page 38
<b>85303 357GNCAV</b>	MECANO AUTOMATIC	page 38
<b>85303 37NCA</b>	MECANO AUTOMATIC	page 38
<b>88008 37RGCA</b>	MECANO AUTOMATIC	page 41



<b>10112 3NCA</b>	CHRONOGRAPH	page 44
<b>10113 37RNCA</b>	CHRONOGRAPH	page 43
<b>10113 3CA</b>	CHRONOGRAPH	page 42
<b>10113 3CAB</b>	CHRONOGRAPH	page 42
<b>85303 357BUCAB</b>	MECANO AUTOMATIC	page 34
<b>53021 3CA</b>	DATE	page 46
<b>53021 3GCA</b>	DATE	page 47
<b>88008 3CA</b>	DAY DATE AUTOMATIC	page 40
<b>88008 3GCA</b>	DAY DATE AUTOMATIC	page 40

DELFIN THE ORIGINAL

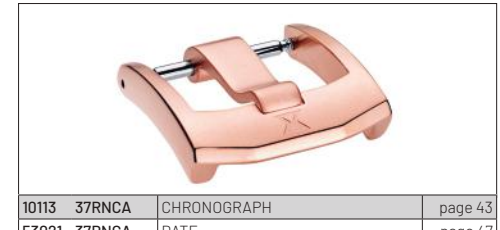

<b>10113 37RNCA</b>	CHRONOGRAPH	page 43
<b>53021 37RNCA</b>	DATE	page 47
<b>85303 357RN</b>	MECANO AUTOMATIC	page 37
<b>85303 357GR</b>	MECANO AUTOMATIC	page 37
<b>88008 37RGCA</b>	DAY DATE AUTOMATIC	page 41



<b>53020 37JC</b>	DIVER DATE LADY	page 49
-------------------	-----------------	---------



<b>53020 37RC</b>	DIVER DATE LADY	page 49
-------------------	-----------------	---------

GRAND OCEAN



09800 3CA	CHRONOGRAPH AUTOMATIC	page 55
09800 357RCA	CHRONOGRAPH AUTOMATIC	page 55
94500 3CA	POWER RESERVE AUTOMATIC	page 57



09800 357GNCA	CHRONOGRAPH AUTOMATIC	page 55
94500 357GNCA	POWER RESERVE AUTOMATIC	page 57

HYDRO-SUB



80128 3BUM	DATE AUTOMATIC	page 63
80128 3NBM	DATE AUTOMATIC	page 63
80128 3NM	DATE AUTOMATIC	page 63
80128 357JNM	DATE AUTOMATIC	page 63

SKYDIVER



80126 357RNM	DATE AUTOMATIC LIMITED EDITION	page 69
80126 3BUM	DATE AUTOMATIC LIMITED EDITION	page 69



80131 3NM	38 DATE AUTOMATIC	page 71
80131 3BUM	38 DATE AUTOMATIC	page 71
10116 3	CHRONOGRAPH	page 73

SKYDIVER



CHRONORALLY

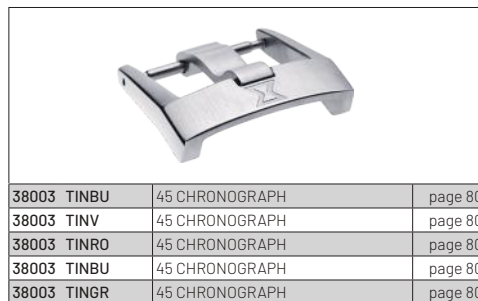

CHRONORALLY

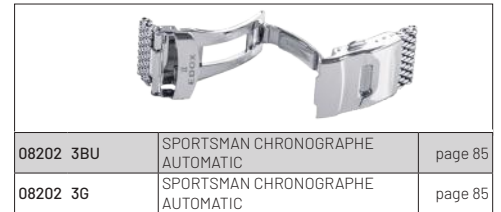

## EDOX QUALITY

### Batteries

In compliance with global regulations and standards, Edox equips its quartz timepieces with mercury-free batteries. This is a positive step towards environmental sustainability with no effect on the watch precision and efficiency.



### Edox double O'ring Crown or Pusher

Since the 70's, Edox has set specific quality and technical standards for ensuring the water resistance of diving timepieces. The double O'ring crown or pusher has been engineered by Edox to allow to increase the resistance to water pressure. Timepieces equipped with crowns or pushers featuring a double O'ring are featuring the special pictogram for easy understanding.



### Helium Escape Valve

Some of our CO-1 and Neptunian timepieces are equipped with a decompression system which allows helium to escape from inside the watch when worn for professional use in pressure chambers (long-term underwater work, crude oil exploration, etc).

The Edox helium valve opens and closes automatically. It is imperative that the models equipped with a non-automatic helium escape valve (such as older Edox timepieces) have the helium valve screwed back in order to guarantee their water resistance.



### Ceramic

Up to four times harder than stainless steel, ceramic is scratch-resistant and thus extremely durable. Mainly used to build the bezels of Edox watches, this material will also prevent the colours from fading.



### Carbon

Carbon first became widespread in industries like aerospace and Formula 1. Exceptionally strong yet surprisingly light, Edox uses this material to build solid case constructions while giving them a very unique and distinctive look.



### Chronometer

When Edox creates a chronometer watch, it means that the movement hosted has successfully undergone the precision test of the Official Swiss Chronometer Testing Institute (COSC), based in Switzerland.

These movements have a certified precision of  $-4/+6$  seconds per day, about three times better than a standard Swiss mechanical movement.



### Bronze

Bronze has natural properties that set it apart from other materials. Bronze does not rust and is therefore widely used in nautical applications and for some Edox diving watch cases, bronze will react with other elements producing a layer of oxidization on its surface. This patina then acts as a protective coating and makes every Edox bronze watch unique.



### DLC

Diamond-Like Carbon (DLC) is a coating in a layer of extremely durable and scratch-resistant carbon particles. It possesses the most desirable physical characteristics of diamond – hardness and durability – and with a sleek beauty. This treatment will improve the durability and the aesthetics of the Edox watch cases.

### Hand-assembled

Every single Edox watch is carefully hand-assembled by qualified Swiss watchmakers in our ateliers in Les Genevez. Each one of them is checked and controlled over a long period of time – by both human beings as well as special equipment to ensure optimal quality.

### Leather

All Edox leather straps are specially cut, stitched and padded by expert craftspeople. Various ways of tanning provide different touch and feel for the straps made of cow or calf leather. It is always important to remember that colors and suppleness of leather are subject to change with time and exposure to external factors. Daily showers or swims are not recommended. If your consumers live a very active lifestyle, especially one involving frequent exposure to salt water and heavy perspiration, we recommend a steel bracelet or rubber strap.



### Luminescence

This technology, branded under the name Super-Luminova, offers brightness in low-light conditions, thanks to a non-radioactive and non-toxic material like the tritium previously employed in the industry. Edox uses Super-Luminova X1 for its highly functional attributes. It is applied on watch parts such as hands, numerals, bezel indices, etc.

### Mother-of-pearl

Resilient, and iridescent, mother-of-pearl is integrated in many Edox dial designs. It is produced inside the shells of certain mollusk shells. This is why each dial made of mother-of-pearl is unique.

### Movements

#### Mechanical movement:

A mechanical movement undergoes several stresses in its life. To ensure it will remain functional and precise as long as possible, Edox simulates watch wearing in its own quality office for every single manual and self-winding mechanism.



### PVD

Edox uses PVD coatings which is a high-performance pollution-free and non-allergenic technology also used in the aeronautic industry, is widely used in watchmaking. The process involves putting a fine titanium coating on stainless steel by condensing a metal vapor in a partial vacuum.

### Rubber

Edox uses genuine high-grade rubber for its straps (a natural material and extremely comfortable). The rubber is silky finished and easy to maintain with the proper cleaning.



### Sapphire crystals

100% of Edox timepieces are fitted with a scratch-resistant crystal that has been cut from a polished slice of solid sapphire. Each has a triple-coated anti-reflective treatment on the internal side for better legibility.



### Stainless Steel

The 316L stainless steel alloy used in Edox cases and bracelets has strong anti-magnetic properties and is optimized for toughness and corrosion resistance. It is also a good choice for consumers allergic to nickels.







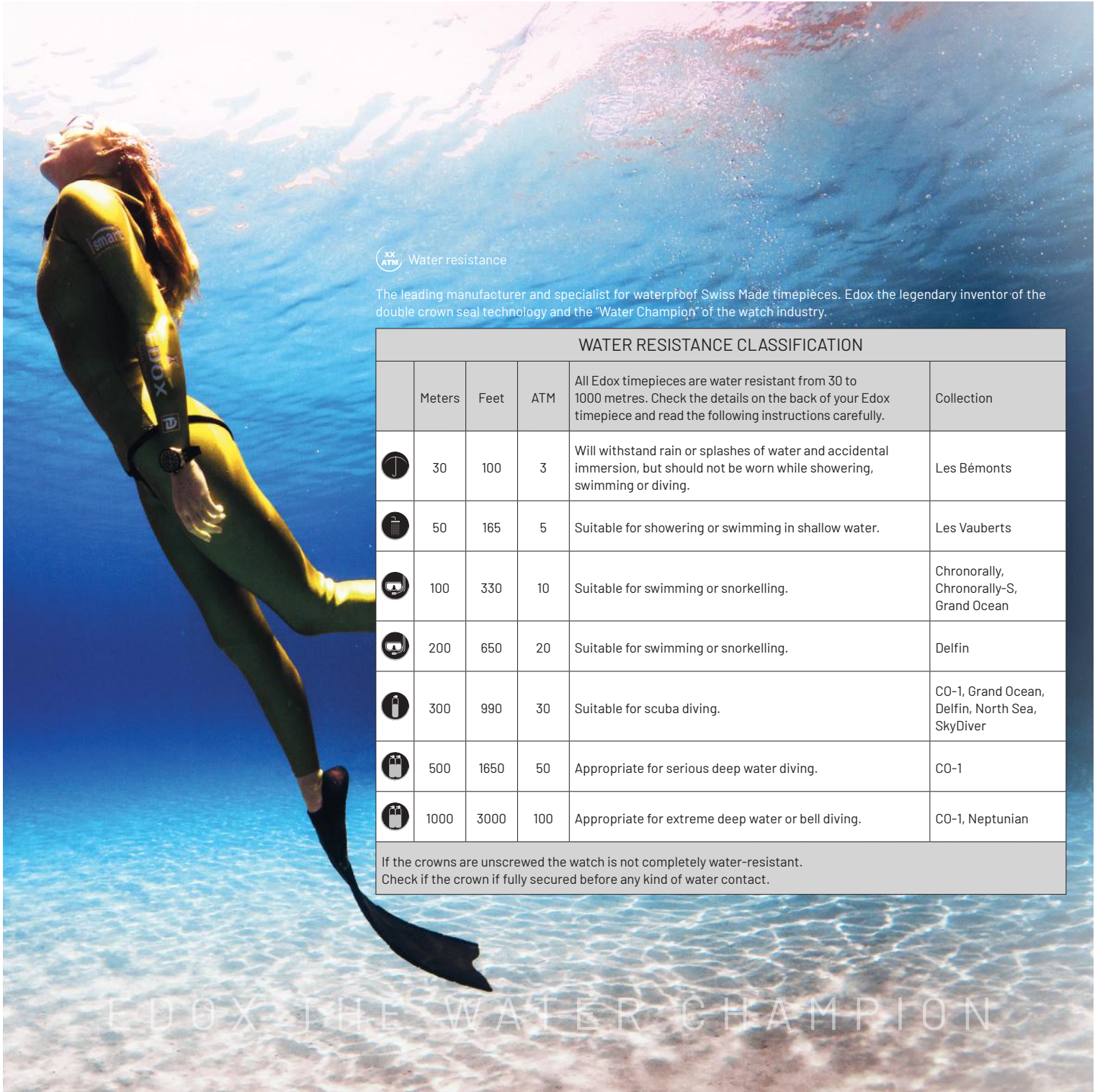

### Titanium

Edox integrates this metal to some of its sports timepieces, as it is as strong as steel but 45% lighter and highly resistant to corrosion. The high tensile strength to density ratio makes it the ideal material for active lifestyles.



**XX ATM** Water resistance

The leading manufacturer and specialist for waterproof Swiss Made timepieces. Edox the legendary inventor of the double crown seal technology and the "Water Champion" of the watch industry.

WATER RESISTANCE CLASSIFICATION					
	Meters	Feet	ATM	All Edox timepieces are water resistant from 30 to 1000 metres. Check the details on the back of your Edox timepiece and read the following instructions carefully.	Collection
	30	100	3	Will withstand rain or splashes of water and accidental immersion, but should not be worn while showering, swimming or diving.	Les Bémonts
	50	165	5	Suitable for showering or swimming in shallow water.	Les Vauberts
	100	330	10	Suitable for swimming or snorkelling.	Chronorally, Chronorally-S, Grand Ocean
	200	650	20	Suitable for swimming or snorkelling.	Delfin
	300	990	30	Suitable for scuba diving.	CO-1, Grand Ocean, Delfin, North Sea, SkyDiver
	500	1650	50	Appropriate for serious deep water diving.	CO-1
	1000	3000	100	Appropriate for extreme deep water or bell diving.	CO-1, Neptunian
If the crowns are unscrewed the watch is not completely water-resistant. Check if the crown is fully secured before any kind of water contact.					

EDOX THE WATER CHAMPION

## REFERENCE NUMBER SYSTEM

The following information will help you on how to handle the Edox reference number, which will give you helpful product information regarding movements, dials and cases.

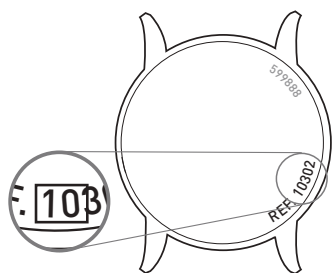

CO-1  
01125 | CLNGN | BUNN | Ø 45 MM

01125 CLNGN BUNN

### MOVEMENT

The first 2 or 3 digits of these five figures represent the Edox movement code. Please refer to the page 112-116 of this catalogue.

01125 CLNGN BUNN

### CASE MATERIAL

The digits and/or letters represent the material and surface treatment (colour) of the case. (See the table)

01125 CLNGN BUNN

### DIAL VARIATIONS

The digits and letters represent the colour and design of the dial.

MOVEMENT	
011	please refer to the page 96

CASE MATERIAL	
3 / 3A / 3B / 3N	Stainless steel 316
3BNM	Stainless steel 316 / White bezel / Steel bracelet
3BN	Stainless steel 316 / White bezel
3BU	Stainless steel 316L / Blue bezel
3BUCA	Stainless steel 316L / Blue bezel Rubber strap
3BUCBU	Stainless steel 316L / Blue details / Blue leather strap
3BUM	Stainless steel 316L / Blue bezel / Steel bracelet
3BUO	Stainless steel 316L / Blue and orange bezel
3BU7	Stainless steel 316L / Dark blue bezel
3C	Stainless steel 316L / Leather strap
3CA	Stainless steel 316L / Rubber strap
CLN5N	Black Carbon / Pink bezel
CLNBUN	Black Carbon / Blue bezel
CLNGN	Black and Grey Carbon
CLNRN	Black and red Carbon
3M	Stainless steel 316L / Steel bracelet
3MV	Stainless steel 316L / Green pusher / Steel bracelet
3N	Stainless steel 316L / Black bezel
3NBU	Stainless steel 316L / Black and blue bezel
3NCA	Stainless steel 316L / Black bezel / Rubber strap
3NGCA	Stainless steel 316L / Black and grey bezel / Rubber strap
3NGM	Stainless steel 316L / Black and grey bezel / Steel bracelet
3NM	Stainless steel 316L / Black bezel / Steel bracelet
3NOCA	Stainless steel 316L / Black and orange bezel / Rubber strap
3NOM	Stainless steel 316L / Black and orange bezel / Steel bracelet
3O	Stainless steel 316L / Black and orange bezel
3OCA	Stainless steel 316L / Orange bezel / Rubber strap
3OM	Stainless steel 316L / Orange bezel / Steel bracelet
3OR	Stainless steel 316L / Orange bezel
3ORC	Stainless steel 316L / Leather strap
3ORCA	Stainless steel 316L / Orange bezel / Rubber strap
3NP18	Stainless steel 316L / Northpole 2018 Edition
3NRCA	Stainless steel 316L / Black and red bezel / Rubber strap
3NRM	Stainless steel 316L / Black and red bezel / Steel bracelet
3NVCA	Stainless steel 316L / Black and green bezel / Rubber strap
3NVM	Stainless steel 316L / Black and green bezel / Steel bracelet
3PBU	Stainless steel 316L / Blue pusher
3PR	Stainless steel 316L / Red pusher
3R	Stainless steel 316L / Black and red bezel or red pusher
3V / 3V2	Stainless steel 316L / Green pusher
37GR	Stainless steel 316L / Grey and pink bezel
37GRM	Stainless steel 316L / Grey and pink bezel / Steel bracelet
37J	Yellow PVD coating
37JC	Yellow PVD coating / Leather strap
37JA	Yellow PVD coating, silver ring
37JG	Yellow PVD coating, golden ring

CASE MATERIAL	
37N	Black PVD coating
37NJ	Black PVD coating, golden pusher
37NNONANN	Black PVD coating, black details / Black NATO Strap
37NNVCV	Black PVD coating, black details / Green leather strap
37NNNAG	Black PVD coating, black details / Black NATO Strap
37NPN	Black PVD coating, black pusher
37NRCN	Black PVD coating, pink details / Black leather strap
37R	Pink PVD coating
37RBU	Yellow PVD coating / Blue bezel
37RC	Yellow PVD coating / Leather strap
37RM	Yellow PVD coating / Steel bracelet
357A / 357J	Stainless steel 316L / Yellow PVD coating
357BR	Stainless steel 316L / Brown PVD coating
357B	Stainless steel 316L / Blue PVD coating
357BU	Stainless steel 316L / Blue PVD coating
357BUNCA	Stainless steel 316L / Black PVD coating, blue bezel
357BRR	Stainless steel 316L / Brown and pink PVD coating
357GC / 357GNCA	Stainless steel 316 / Black and Grey PVD coating
357JBUCA	Stainless steel 316L / Pink PVD coating / Blue bezel / Rubber strap
357JCA	Stainless steel 316L / Yellow PVD coating / Rubber strap
357JVM	Stainless steel 316L / Green and yellow PVD coating / Steel bracelet
357RBU	Stainless steel 316L / Pink PVD coating / Blue PVD bezel / Steel bracelet
357RC	Pink PVD coating / Leather strap
357RCA	Stainless steel 316L / Pink PVD coating / Rubber strap
357RM	Pink PVD coating / Steel bracelet
357N	Stainless steel 316L / Black PVD coating
357NCA	Stainless steel 316L / Pink PVD coating / Black bezel / Rubber strap
357R	Stainless steel 316L / Pink PVD coating
357RCA	Stainless steel 316L / Pink PVD coating / Rubber strap
357RD	Stainless steel 316L / Pink PVD coating, diamonds
357RN	Pink and black PVD coating
357RNCA	Stainless steel 316L / Pink PVD coating / Black PVD bezel / Rubber strap
TINBU1	Titanium / Blue PVD coating
TIN / TINR	Titanium

DIAL VARIATION	
AIBU	Silver / Blue indices
AID / AID2	Silver / Golden indices
AIN / AIN2	Silver / Silver indices
AINO	Silver / Black indices
AIR	Silver / Pink indices
ABUN	Silver / Blue and silver indices
AR	Silver / Roman numberings
BEBN	Beige / Silver Breguet numberings
BEBR	Beige / Pink Breguet numberings
BEIR	Beige / Pink indices
BER	Beige / Roman numberings
BIBU	White / blue indices
BINN	White / Silver and black indices
BINR	White / Black and pink indices

DIAL VARIATION	
BIR	White / Pink indices
BRID	Brown / Yellow indices
BRIN	Brown / Silver indices
BRIR	Brown / Pink indices
BU	Blue
BUBEB	Blue / Nickel Breguet numberings
BUBG	Blue / White and grey indices
BUBN	Blue / Silver Breguet numberings
BUNN	Blue / Black and silver indices
BUIB1	Blue / Black details
BUID	Blue / Golden indices
BUIIN / BUIIN7	Blue / Silver indices
BUIO	Blue / Silver and orange indices
BUIR	Blue / Pink indices
BUV3	Blue / Green indices
DI	Golden
GID	Grey / Golden indices
GIN	Grey / Silver indices
GIR	Grey / Pink indices
GR3	Grey / Red details
NADN	Mother-of-pearl / Diamonds and silver indices
NADR	Mother-of-pearl / Diamonds and pink indices
NAIN	Mother-of-pearl / Silver indices
NANN	Mother-of-pearl / Black indices
NAIR	Mother-of-pearl / Pink indices
NBN	Black / Silver Breguet numberings
NBUJ	Black / Blue and yellow indices
NBUN	Black / Silver and blue indices
NBUR	Black / Blue and pink indices
NBU	Black / Blue indices
NIBU	Black / Blue indices
NID	Black / Golden indices
NIN / NIN2	Black / Silver indices
NINB	Black / Black and beige indices
NINBU	Black / Silver and blue indices
NING	Black / Black and grey indices
NINJ	Black / Black and yellow indices
NINO	Black / Silver and orange indices
NINRO	Black / Silver and red indices
NIR / NIR7	Black / Pink indices
NBUR	Black / Blue and red indices
NOBU	Black / Orange and blue indices
NOJ / NOJ3	Black / Orange and yellow indices
N00	Black / Orange indices
NOR	Black / Orange indices
NNO	Black / Black and orange details
NNP18	Black / Northpole 2018 Edition
NNV	Black / Green details
NNR	Black / Pink details
NRO	Black / Red indices
NV	Black / Green indices
VID	Green / Golden indices





Visit Edox at [www.edox.ch](http://www.edox.ch)



EDOX SWISS WATCHES  
LA SAGNE AU DROZ 18  
CH-2714 LES GENEVEZ  
SWITZERLAND

TEL. +41 32 484 70 10 FAX. +41 32 484 70 19  
INFO@EDOX.CH WWW.EDOX.CH

The models and product lines in this 2021-2022 catalogue are subject to change without notice. All models are subject to availability. The information provided refers to the model named, or is of a general nature. Not all watches and movements in this catalogue are shown in their actual size. The colours of the watches and movements illustrated may vary due to the printing process. No part of this brochure may be reproduced, scanned or transmitted either online or in any form without prior written permission from Edox.

Edox is a registered trademark.

Printed in Switzerland

